



# S200-Series

INTERCONNECTED ENTRANCE LOCKS



**Security & Safety**  
Proven Source. Proven Solutions.™

**SCHLAGE**®  
Access Control and Key Systems Management

*Application*

*Multi-family dwellings, hotel/motel, office and light duty commercial use.*

*Performance Features*

Simultaneous retraction of deadbolt and latch for single-motion egress.

Independent heavy duty torsion springs.

Handicap compliant levers.

Patented reinforcer for deadbolt strike in wood frame to withstand kicking and prying.

Free-spinning steel-reinforced collar protects deadbolt cylinder from wrenching.

Extra-strong Everest keys standard for commercial customers.

INDEX	
Cylinders	4 - 5
Designs & Finishes	2
Door Handing	8
Door Preparation	1
Functions	3
How to Order	9
Interchangeable Core	5
Latches	6
Primus® High Security Cylinders	4 - 5
Specifications	1
Strikes	7

*Exploded / Cutaway View*

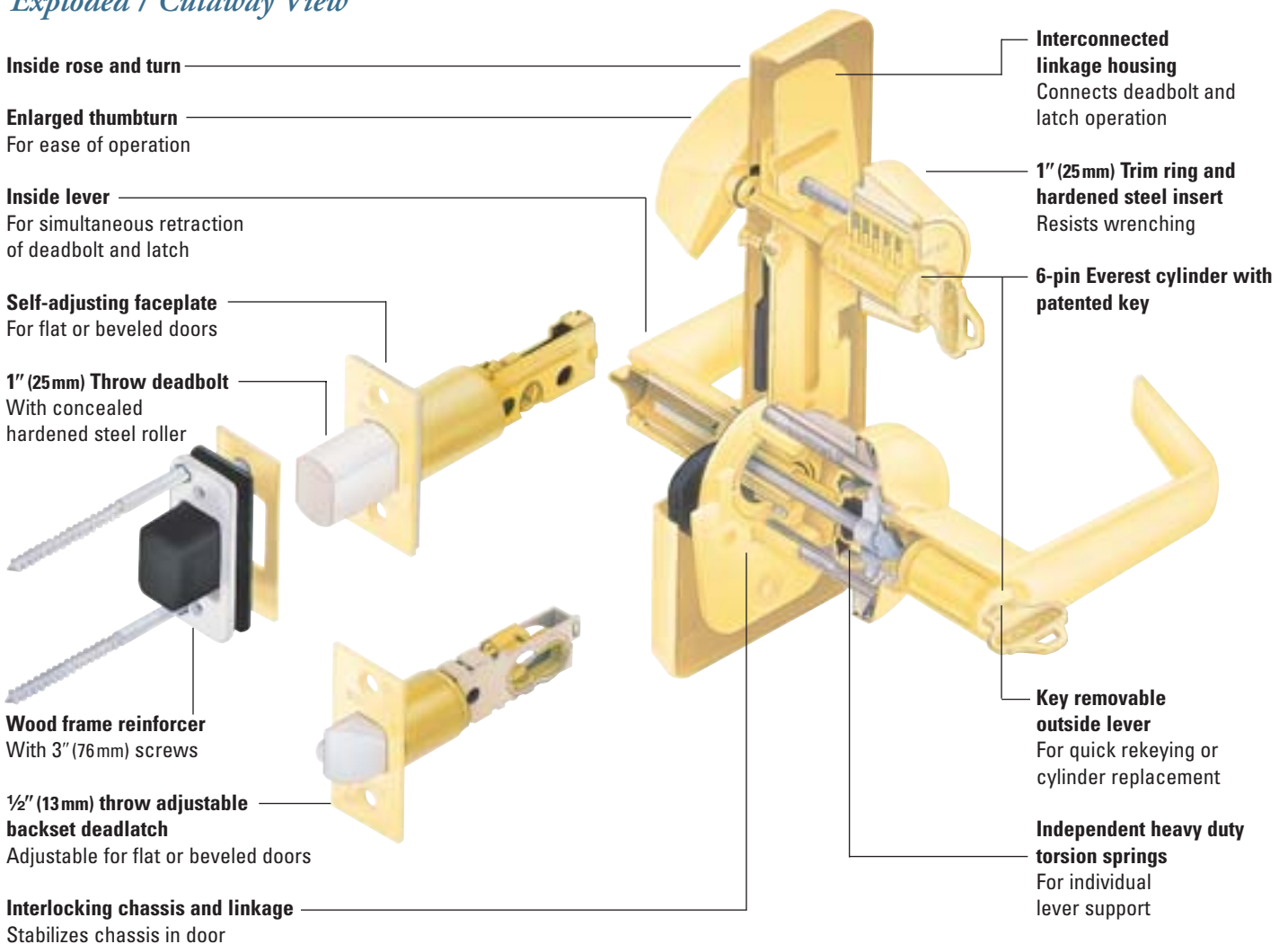

## Specifications

### Handing:

Not handed, except Flair design.

### Door Thickness:

1 3/8" to 2" (35 mm-51 mm).

**Backset:** 2 3/8" (60 mm) Standard, 2 3/4" (70 mm) and 5" (127 mm) available.

### Fronts:

Brass or bronze. 1 1/8" x 2 1/4" (29 mm x 57 mm) square corner, beveled, for 2 3/4" backset standard.

For availability with specific backsets, see page 6.

### Lock Chassis:

Steel, zinc dichromate plated for corrosion resistance.

**Deadbolt:** 1" (25 mm) throw with hardened steel roller, and 1" (25 mm) housings standard.

### Latch Bolt:

Brass, chrome plated, 1/2" (13 mm) throw, deadlocking.

**Exposed Trim:** Levers are zinc base, plated to match finish symbols. Roses, escutcheons, latch faceplates and strikes are wrought brass or bronze.

### Strike:

T-strike 1 1/8" x 2 3/4" (29 mm x 70 mm) x 1 1/8" (29 mm) lip to center with box standard. Optional strikes, lip lengths and ANSI strike box available. See page 7.

### Cylinder & Keys:

Commercial: 6-pin patented Everest C123 keyway standard with two nickel silver keys per lock.

Residential: 6-pin C keyway, keyed 5-pin.

### Keying Options:

Interchangeable core and Primus® high security cylinders. Master keying, grand master keying, and construction keying.

### Warranty:

Commercial: three-year limited.

Residential: Full mechanical lifetime.

## Door Preparation

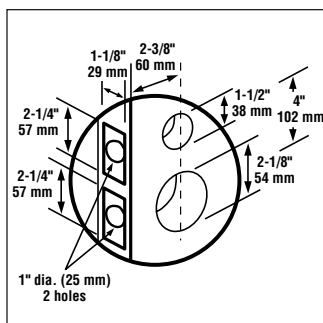

## Certifications

### ANSI

Meets or exceeds A156.12 Series 5000, Grade 2 strength and operational requirements.

### Federal

Meets FF-H-106C.

### California State Reference Code

(Formerly Title 19, California State Fire Marshal Standard)

All levers with returns comply; levers return to within 1/2" of door face.

### UL / cUL:

All locks listed for A label single doors, 4' x 8'.

Letter F and UL symbol on latch front indicate listing.

UL437 Listed locking cylinder optional: specify

Primus 20-500 Series cylinder.



*Designs & Finishes*

**Outside**



**FLAIR**

Symbol: FLA  
 Material: Pressure cast zinc  
 Finishes: 605, 606, 609, 612,  
 613, 625, 626



605

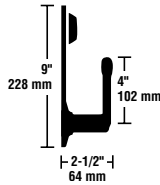

**Inside**



**FLAIR**

Symbol: FLA  
 Material: Pressure cast zinc  
 Finishes: 605, 606, 609, 612,  
 613, 625, 626

605

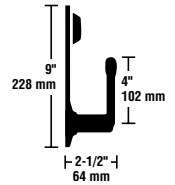

**JUPITER**

Symbol: JUP  
 Material: Pressure cast zinc  
 Finishes: 605, 606, 613,  
 625, 626



626

Matches  
 D-Series **ATHENS**  
 and L-Series **07**  
 designs

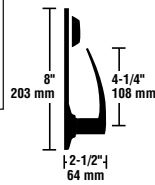

**SATURN**

Symbol: SAT  
 Material: Pressure cast zinc  
 Finishes: 605, 606, 609, 612,  
 613, 625, 626

626

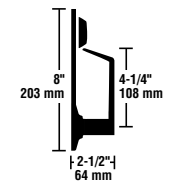

**NEPTUNE**

Symbol: NEP  
 Material: Pressure cast zinc  
 Finishes: 605, 606, 609,  
 613, 625, 626



626

Matches  
 D-Series **SPARTA**  
 and L-Series **17**  
 designs

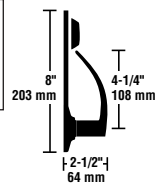

**METEOR**

Material: Pressure cast zinc  
 Dimensions: 3-1/4" x 8-1/4" x 3/16"  
 Finishes: 605, 606, 609, 612,  
 613, 625, 626

606



**SATURN**

Symbol: SAT  
 Material: Pressure cast zinc  
 Finishes: 605, 606,  
 613, 625, 626



626

Matches  
 D-Series **RHODES**  
 and L-Series **06**  
 designs

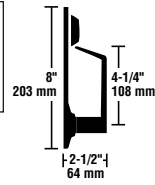

*Note: Neptune and Jupiter designs are offered with Saturn inside escutcheon only.*

**Finishes**

- 605 Bright Brass
- 606 Satin Brass
- 609 Satin Brass, Blackened
- 612 Satin Bronze
- 613 Oil Rubbed Bronze
- 625 Bright Chromium Plated
- 626 Satin Chromium Plated

Designs available with full size interchangeable core option for all keyed functions.

*Functions*

ANSI A156.12-1992, Grade 2

SCHLAGE ANSI  
**S210PD F95**

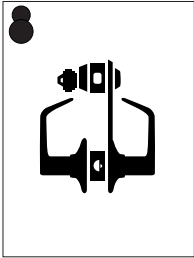

**Entrance, Single Locking**

Deadbolt operated by key from outside or by turn unit from inside. Bolt automatically deadlocks when fully thrown. Latchbolt retracted by lever from either side. Turning inside lever retracts deadbolt and latchbolt simultaneously for immediate exit.

SCHLAGE ANSI  
**S280PD F98**

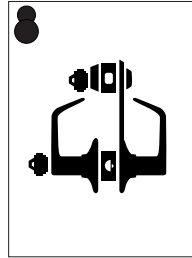

**Storeroom Lock**

Deadbolt operated by key from outside or by turn unit from inside. Bolt automatically deadlocks when fully thrown. Outside lever is fixed. Entrance by key only. Inside lever retracts both latch and deadbolt simultaneously for immediate exit. Latch automatically deadlocks when door is closed.

**S251PD F97**

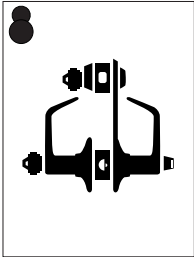

**Entrance, Double Locking**

Deadbolt operated by key from outside or by turn unit from inside. Bolt automatically deadlocks when fully thrown. Outside lever unlocked by key from outside when locked by turn button on inside lever. Turning inside lever retracts deadbolt and latchbolt simultaneously for immediate exit. Latch automatically deadlocks when door is closed.

**S290**

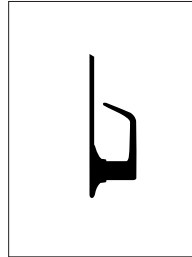

**Single Dummy Trim**

Dummy trim for one side of door. Used for door pull or as matching inactive trim.

**S270PD**

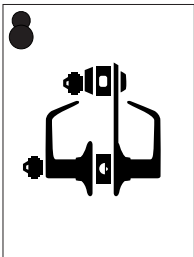

**Classroom Lock**

Deadbolt operated by key from outside or by turn unit from inside. Bolt automatically deadlocks when fully thrown. Outside lever is locked and unlocked by key from outside. Turning inside lever retracts deadbolt and latchbolt simultaneously for immediate exit. Latch automatically deadlocks when door is closed.

 Keyed functions available with full size interchangeable core option.

## Standard Cylinders

Schlage® locks are provided with cylinders precision built to extremely close tolerances and the highest standards of accuracy. Using only solid brass plugs, extruded brass shells, phosphor bronze springs, nickel silver keys and pins, ensures long life and ease of operation.

Conventional cylinders are available in Classic keyways or in the newly patented Everest® keyways. Specify keyway to differentiate between Everest and Classic. Example: C (Classic) vs. C123 (Everest).

## Primus® High Security Cylinders

Primus high security cylinders are available to add patented key control and varying degrees of geographical exclusivity to most Schlage 6-pin key systems, whether Everest or Classic keyways.

In addition to a conventional pin tumbler mechanism, Primus cylinders incorporate a patented finger pin and sidebar design providing a “dual-locking” cylinder that is virtually pick-proof. Resistance to drilling and other physical attack is optional by specifying 20-500 Series UL437 Listed cylinders.

Classic Primus cylinders are recommended for upgrading existing Classic key systems. Due to its extended patent life, the newly designed Everest Primus is recommended for new key systems and for upgrading existing Everest® key systems. Specify keyway to differentiate between Everest and Classic. Example: CP (Classic) vs. C123 (Everest).

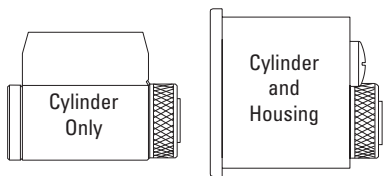

**Cylinders for Deadbolt (Top)**

Cylinder Only	Cyl. & Housing	Description
22-002	22-019	6-Pin conventional (standard)
20-729	20-730	Primus high security
20-529	20-530	Primus UL437 Listed high security

Cylinder only available 606 and 626 finish only.  
 Cylinder with housing available 605, 606, 609, 612, 613, 625, 626.  
 Everest C123 keyway standard for Commercial; C keyway standard for Residential.

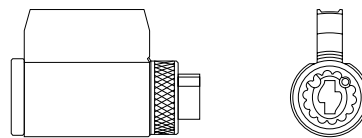

**Cylinders for Keyed Levers (Bottom)**

Cylinder	Description
21-028	6-Pin conventional cylinder (standard)
20-752	Primus high security cylinder
20-552	Primus UL437 Listed high security cylinder

Available 606 and 626 finish only.  
 Everest C123 keyway standard for Commercial; C keyway standard for Residential.  
 Sleeve S605-192 included.

## Interchangeable Core



Schlage® figure-8 interchangeable core (IC) locksets allow immediate rekeying at the door simply by using the special *control key* to replace the core in seconds.

IC locksets are available in all designs except Flair; Full size interchangeable cores can be integrated into any 5 or 6-pin Schlage key with no adverse affects on keying capacity.

To order complete locks with full size cores, change suffix from PD to RD. Example: S251RD. To order locks *less core*, change suffix to JD. To order with full size *construction core*, change suffix to TD.



626

### JUPITER

Symbol: JUP  
Material: Pressure cast zinc  
Finishes: 605, 606, 613, 625, 626

Matches  
D-Series *ATHENS*  
and L-Series *07*  
designs

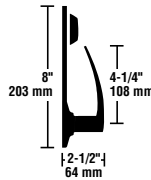

626

### NEPTUNE

Symbol: NEP  
Material: Pressure cast zinc  
Finishes: 605, 606, 609, 613, 625, 626

Matches  
D-Series *SPARTA*  
and L-Series *17*  
designs

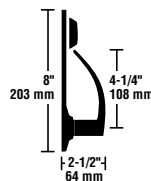

626

### SATURN

Symbol: SAT  
Material: Pressure cast zinc  
Finishes: 605, 606, 613, 625, 626

Matches  
D-Series *RHODES*  
and L-Series *06*  
designs

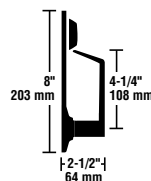

## Cores and IC Cylinders & Parts

### Full Size Core

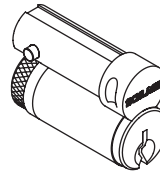

### Full Size Interchangeable Cores

Number	Description
23-030	Conventional core
20-740	Primus high security core

Available 606 and 626 finish only. Everest C123 keyway standard for Commercial; C keyway standard for Residential.

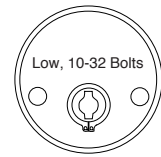
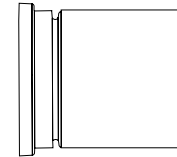
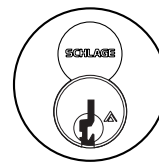

### IC Cylinders for Deadbolt (Top) Tailpiece not included.

Number	Description
22-061	Housing less core
22-064	Housing with conventional core
20-784	Housing with Primus core

Available 605, 606, 609, 612, 613, 625, 626. Everest C123 keyway standard for Commercial; C keyway standard for Residential.

### IC Installation Tool

This tool is used to install the driver and retainer for full size IC in Schlage knobs and levers. Its other ends are designed to install and remove mortise cylinder housings and test mortise cylinder cam action for both small format and full size interchangeable core cylinders.

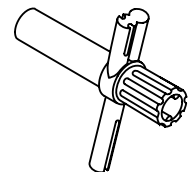

M504-413  
(Order separately.)

### Latches & Deadbolts

The standard universal backset deadlatch fits both 2 3/8" (60 mm) and 2 3/4" (70 mm) backsets. They are adjustable for flat or beveled edge doors and have a 1/2" (13 mm) throw. Orders for complete locks are provided with a G506-815 sleeve for 7/8" diameter latches installed in doors with 1" (25 mm) edge bore.

Deadbolts have 1" (25 mm) housings and 1/2" (13 mm) throw.

All latches and bolts for the S200-Series have 1 1/8" x 2 1/4" square corner fronts. Standard latches are shown in bold type.

**Note: Failure to use the below referenced latches and fire cup, included with the lockset, will invalidate the UL Listing.**

**Sleeve**  
G506-815



Used on 7/8" (22 mm) diameter latch housings in 1" (25 mm) edge bore. Furnished standard with complete locks.

**Door Reinforcement**

Schlage® reinforcing units help prevent the collapse of hollow metal doors when locksets are tightly mounted.

**Door Prep**

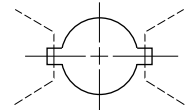

**Deadbolt (top)**  
Fixed Backset

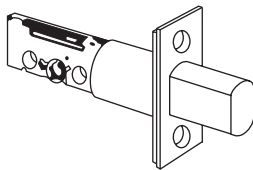

**Latch (bottom)**  
Adjustable Backset

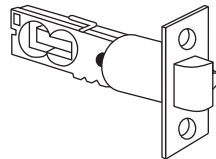

**A501-566**  
1 3/4" (44 mm) Doors

**A501-565**  
1 3/8" (35 mm) Doors

Backset	Deadbolt	Deadlatch	Combo Pair
2 3/8"	<b>12-073</b>	<b>16-228</b>	<b>16-230</b>
2 3/4"	12-076		16-231
5"	12-082	16-132*	16-232

\* 5" backset deadlatch includes A501-878 latch front adapter for 1 1/8" prep.

Specify finish.

**Latch Front Adapter**  
A501-878

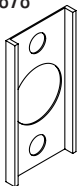

Used to convert 1" (25 mm) wide square front faceplates for 1 1/8" (29 mm) wide door preparations. Furnished in black plastic. Order in multiples of 100.

*Strikes*

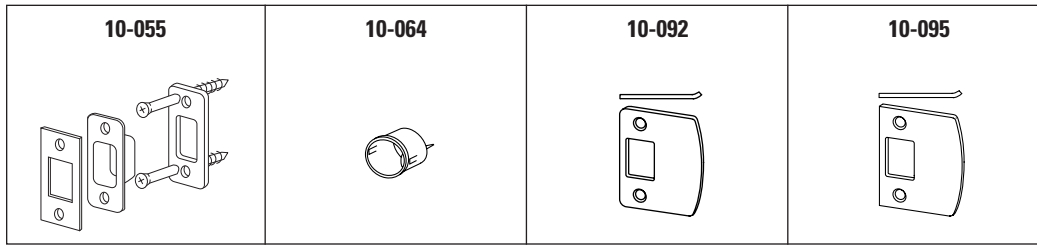

<b>Deadbolt Strikes</b>		
Part Number	Description	Lip Length
10-055	Square corner, box, 1 1/8" x 2 3/4", standard	—
10-064	Circular drive-in, thimble strike, 1 3/16" diameter, 494 (for 626) only	
10-092	1/4" Radius round corner, full lip, no box, 1 5/8" x 2 1/4"	1 1/8"
10-095	Square corner, full lip, no box, 1 5/8" x 2 1/4"	

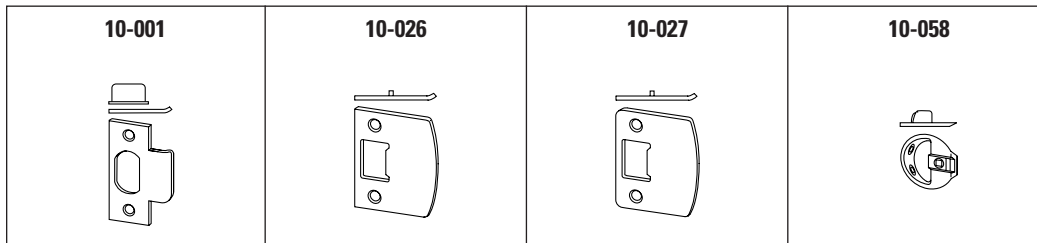

<b>Deadlatch Strikes</b>		
Part Number	Description	Lip Length
10-001	Square corner, T-strike, box, 1 1/8" x 2 3/4", standard	1 1/8"
10-026	Square corner, full lip, no box, 1 5/8" x 2 1/4"	
10-027	1/4" Radius round corner, full lip, no box, 1 5/8" x 2 1/4"	1 7/32"
10-058	Circular, adjustable, 1 3/4" diameter, 605 and 626 only	

<b>Deadbolt/Deadlatch Strike Combinations</b>		
Combo Number	Deadbolt Strike	Deadlatch Strike
10-250	10-055	10-001, 1 1/8" Lip
10-251	10-064	10-001, 1 1/8" Lip
10-252	10-055	10-026
10-253	10-064	10-026
10-255	10-055	10-027
10-256	10-064	10-027
10-257	10-092	10-027
10-258	10-064	10-058

### *Door Handing*

Specify handing when ordering Flair design locksets and any split finish locksets. All other Schlage S200-Series locks are non-handed. Follow the diagram to correctly determine the hand of the door.

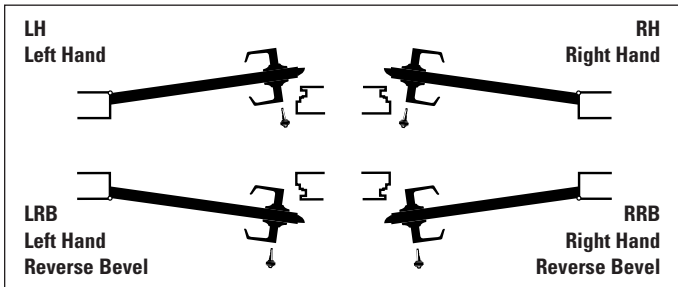

## How to Order

To order Schlage products, descriptive data should be in the same sequence as shown.

Line Item	Qty	Product	Outside		Inside		Hand	Latch	Strike	Dim	Additional Details
			Des	Fin	Des	Fin					
1	2	3	4	5	6	7	8	9	10	11	12

- 1 Line item number
- 2 Quantity
- 3 Complete model number with function and cylinder type

To order cylinder options, change “PD” at the end of the model number as follows:



S251PD Standard

S251LD Less standard cylinder (For Primus cylinder, specify this option and order Primus cylinder separately.)



S251JD Prepared for full size interchangeable core, less core

S251RD With full size conventional interchangeable core installed. Order control keys separately.

S251TD With full size (temporary) construction core installed. Order all keys separately.

- 4/5 Outside design / finish.
- 6/7 Inside design / finish. Leave blank if same as outside.
- 8 Hand (Required only for Flair design and split-finish locksets)
- 9 Latch. Leave blank for standard or specify part number for optional latch. LLL=Less Latch.
- 10 Strike. Leave blank for standard or specify part number for optional strike. LLL=Less Strike.
- 11 Dimension for strike lip lengths. See strike page for availability of specific dimensions with specific strikes.
  - 100 = 1"
  - 118 = 1 1/8"
  - 114 = 1 1/4"
  - 138 = 1 3/8"
  - 112 = 1 1/2"
  - 134 = 1 3/4"
  - 200 = 2"
- 12 Keying detail (e.g. key symbol, keyway, bitting) and other special requirements.

### EXAMPLE

Line Item	Qty	Product	Outside		Inside		Hand	Latch	Strike	Dim	Additional Details
			Des	Fin	Des	Fin					
1	5	S251PD	FLA	605			RH				KA4
2	5	S210LD	SAT	626							Less Cylinder
3	5	20-729		626							1AA-100AA

**Note:** Schlage order forms are available at no charge by contacting your IR Security & Safety Consultant or Customer Service.

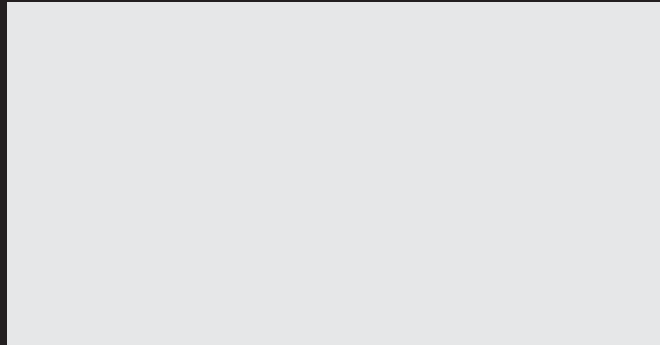

### **Administrative Offices**

111 Congressional Blvd.,  
Suite 200  
Carmel, IN 46032  
(800) 847-1864  
FAX (800) 452-0663

### **Commercial Customer Service**

2315 Briargate Parkway, Suite 700  
Colorado Springs, CO 80920  
(800) 847-1864  
FAX (800) 452-0663  
Order Entry  
FAX (800) 452-0665

### **Internet**

<http://www.schlage.com>

### **Fax-On-Demand**

(888) 321-3228

### **Canada and Latin America**

Ingersoll-Rand Architectural Hardware  
1076 Lakeshore Road East  
Mississauga, Ontario, L5E 1E4, Canada  
(905) 403-1800  
FAX (905) 278-1413

### **North-East Asia**

23/F, 625 Kings Road  
Northpoint  
Hong Kong  
(852) 2235-0600  
FAX (852) 2265-1409

### **Southeast Asia / Australia / NZ**

IR ARCHITECTURAL HARDWARE LTD.  
P.O. Box 19-347  
437 Rosebank Road,  
Avondale, Auckland, New Zealand  
+64 (0) 9-829-0550  
FAX +64 (0) 9-829-0552  
[www.irarchitecturalhardware.co.nz](http://www.irarchitecturalhardware.co.nz)

### **Mexico**

IR Security and Safety  
Blvd. Centro Industrial No. 11  
Puentas de Vigag, Tlalnepantla  
Estado de Mexico, 54070 Mexico  
+525-5-8503-6614

### **United Kingdom**

IR Security and Safety Ltd.  
Bescot Crescent  
Walsall, West Midlands WS1 4DL  
United Kingdom  
+44 (0)1922 707400  
FAX +44 (0)1922 646303  
[www.irsecurityandsafety.co.uk](http://www.irsecurityandsafety.co.uk)



### **SCHLAGE**

111 Congressional Blvd., Suite 200  
Carmel, IN 46032  
800-847-1864  
800-452-0663 Fax  
[www.schlage.com](http://www.schlage.com)

An  Ingersoll-Rand business